

RoHS

This products can apply to the SESO Doc NO. QA-3-04-005 of Environmental&Material Management Rules

■ Specifications :

- Voltage rating: 250V AC / DC
- Current rating: 3A AC / DC
- Withstanding voltage: 650V AC/minute
- Temperature range: -40°C~+105°C
- Insulation resistance: ≥100MΩ
- Contact resistance: ≤30mΩ
- After environmental testing: ≤60mΩ
- Suitable SESO Terminal: 2010T
- Suitable SESO Wafer: 2010WRS / 2010WR
- "★" Critical dimension

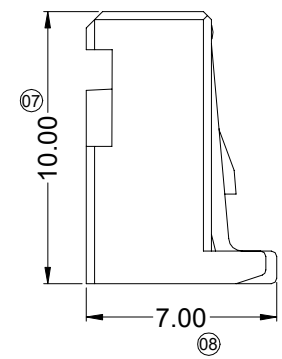
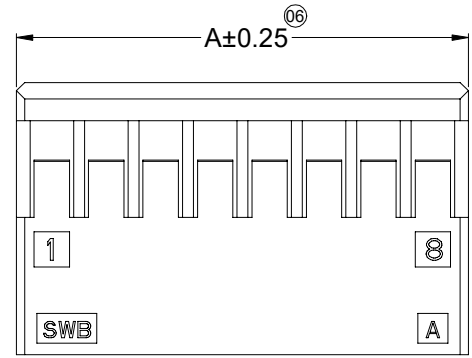
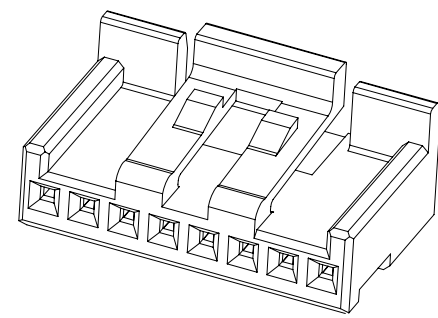
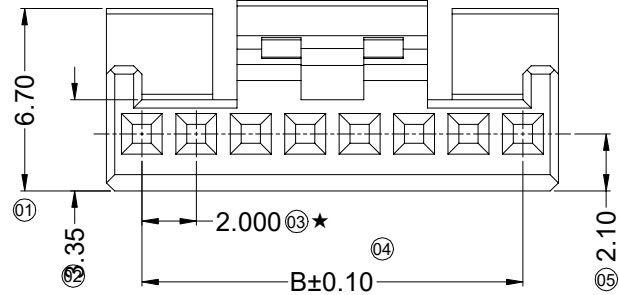

2010 H X-XX X-PT BK

① ② ③ ④ ⑤ ⑥ ⑦

- ① Series No.
- ② Category: H-HSG
- ③ Welding Board Angle: Blank-Ordinary
- ④ Row No.-Pin No Per Row: XX-02~12P
- ⑤ Special No.: Blank-Ordinary
- ⑥ Material: PT-PBT 94V-0
- ⑦ Color: BK-Black

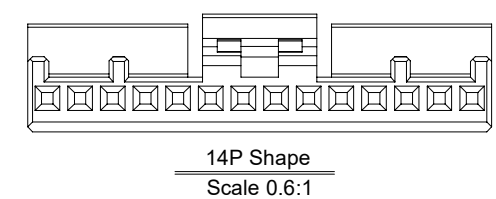
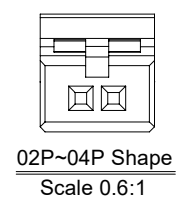
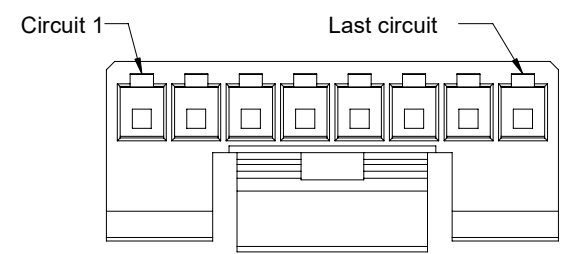

Poles	Dimensions (mm)	
	A	B
02	7.00	2.00
03	7.90	4.00
04	8.60	6.00
05	12.00	8.00
06	12.60	10.00
07	15.60	12.00
08	16.60	14.00
10	20.60	18.00
14	28.40	26.00

DATE	REV	ECN NO.	DESCRIPTION	MODIFY	APPROVAL	GENERAL TOLERANCE				PART NO.					
						.X	±0.35	.XX	±0.25	.XXX	±0.15	X.°	±2°	2010H-XX-PTBK	
						PROJECT	APPROVAL	CHECK	DRAWN	DATE	TITLE				
											2.00 mm Crimp Style Connectors				
						PROJECT	APPROVAL	CHECK	DRAWN	DATE	UNIT	SCALE	SHEET	REV	NUMBER
											2017/12/22				
2023/08/15	C	/	Update Drawing Frame	Starry lin	Larry Yang	PROJECT	APPROVAL	CHECK	DRAWN	DATE	TITLE				
2020/03/16	B	EN20200316003	Update Drawing Frame	Alan qin	Robing						2.00 mm Crimp Style Connectors				
1	2	3	4	5	6	7	8								

SMS 东莞市思索技术股份有限公司
Dongguan SESO Technology Co.,Ltd.

RoHS

This products can apply to the SESO Doc NO. QA-3-04-005 of Environmental&Material Management Rules

■ Specifications :

- Voltage rating: 250V AC / DC
- Current rating: 3A AC / DC
- Withstanding voltage: 650V AC/minute
- Temperature range: -40°C~+105°C
- Insulation resistance: ≥100MΩ
- Contact resistance: ≤30mΩ
- After environmental testing: ≤60mΩ

- Used In SESO Housing: 2010H
- "★" Critical dimension

2010 T X-P SN X-X
① ② ③ ④ ⑤ ⑥ ⑦

- ① Series Number
- ② Category: T-Terminal
- ③ Shape: Blank-Ordinary H-High Crimp
- ④ Material: P-Phosphor bronze
- ⑤ Plating code: SN-Bright tin
- ⑥ Plating method: Blank-Stamping before plating
B-Plating before stamping
- ⑦ Mold No./Mark/Special No. : Blank-Ordinary

2010TH-PSN	2.25	2.06	AWG#20(0.5mm ²)	1.50mm (Max)
2010T-PSN	2.00	1.60	AWG #22~24 (0.35~0.22mm ²)	
PART NO	Dim A	Dim B	Wire Size	Insulation O.D.

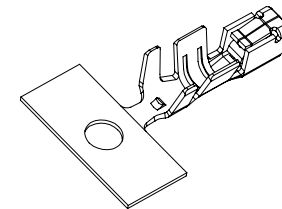
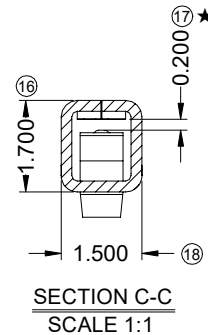
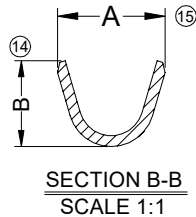
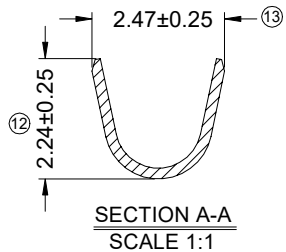
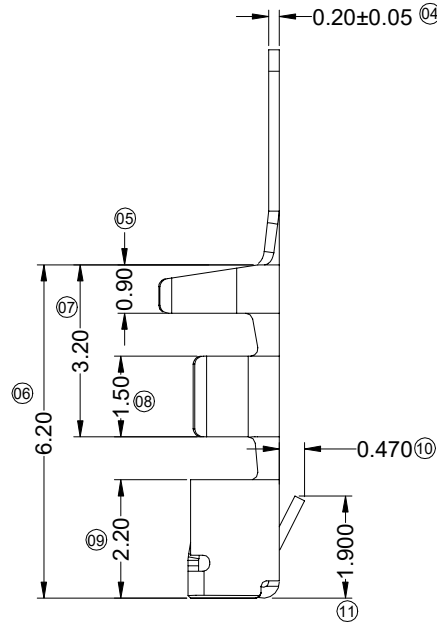
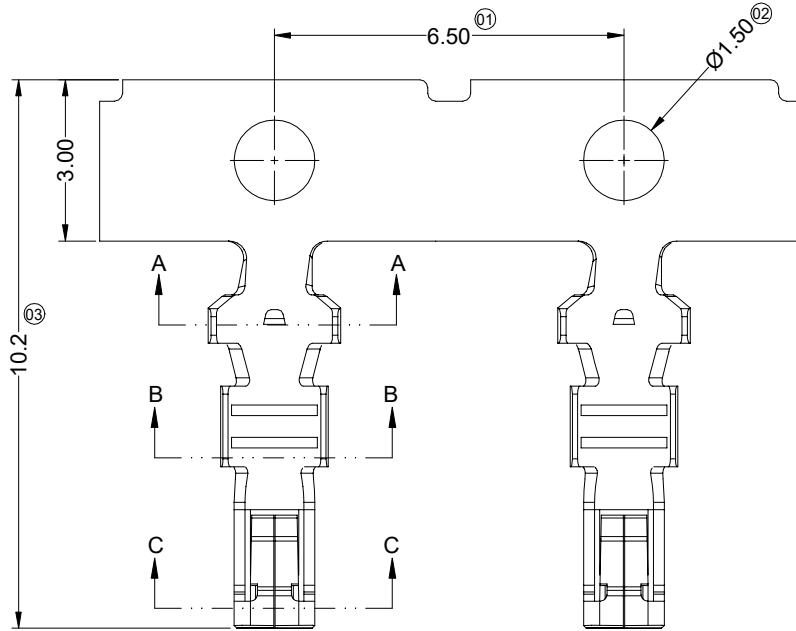

						<p>SMS 东莞市思索技术股份有限公司 Dongguan SESO Technology Co.,Ltd.</p>				PART NO. 2010TX-PSN				
						<p>APPROVAL CHECK DRAWN DATE</p>				TITLE 2.00 mm Crimp Style Connectors				
						<p>PROJECT Jack Zhang Larry Yang Starry lin 2017/12/22</p>				<p>UNIT SCALE SHEET REV NUMBER</p>				
						<p>GENERAL TOLERANCE</p>				<p>mm 1:1 1/1 C A-275</p>				
						<p>.X ±0.30</p>								
						<p>.XX ±0.20</p>								
						<p>.XXX ±0.10</p>								
						<p>X.° ±2°</p>								
						<p>DATE REV ECN NO. DESCRIPTION MODIFY APPROVAL</p>								
						<p>2023/08/15 C / Update Drawing Frame Starry lin Larry Yang</p>								
						<p>2020/03/16 B EN20200316003 Add high crimp specification Alan qin Robing</p>								

RoHS

This products can apply to the SESO Doc NO. QA-3-04-005 of Environmental&Material Management Rules

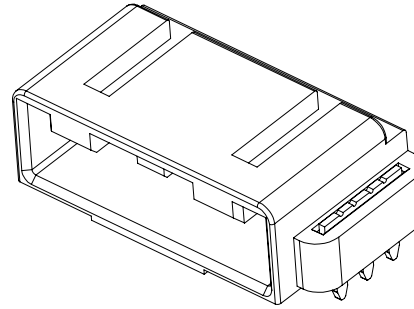
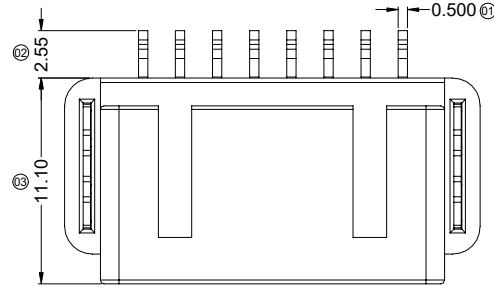

■ Specifications :

- Voltage rating: 250V AC / DC
- Current rating: 3A AC / DC
- Withstanding voltage: 650V AC/minute
- Temperature range: -40°C~+105°C
- Insulation resistance: ≥100MΩ
- Contact resistance: ≤30mΩ
- After environmental testing: ≤60mΩ
- Material(Pin): Brass
- Material(Solder Tabs): Brass
- Mates With SESO Housing: 2010H
- "★" Critical dimension

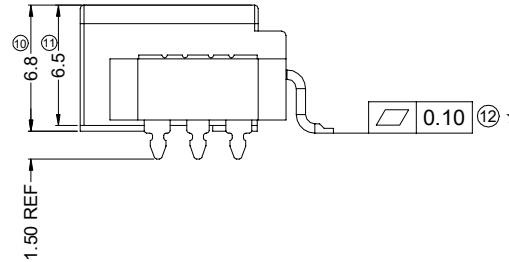
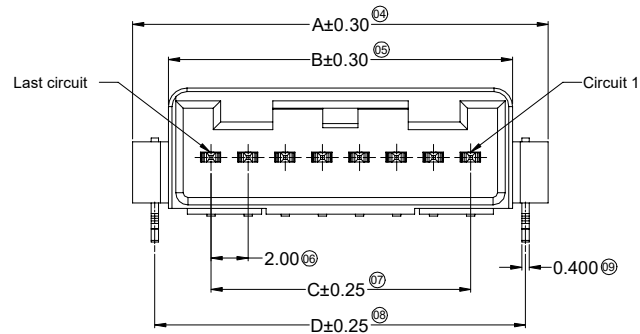

2010 W R S-XX X -PP SN BK R

① ② ③ ④ ⑤ ⑥ ⑦ ⑧ ⑨ ⑩

- ① Series No.
- ② Category: W-wafer
- ③ Connector Type: R- Right Angle 90°
- ④ Mouting Type: S-SMT
- ⑤ Row No.-Pin No Per Row: XX-02P~14P
- ⑥ Plug the Pin & Special No.:
- ⑦ Material: PP-PPS 94V-0
- ⑧ Plating Code: SN-Bright tin
- ⑨ Color: BK-Black
- ⑩ Packing : R-Reel

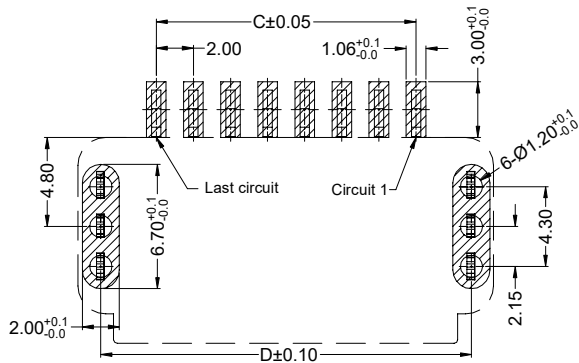

RECOMMENDED P.C.B LAYOUT
(TOLERANCE:±0.05)

Poles	Dimensions (mm)			
	A	B	C	D
02	12.90	9.05	2.00	10.58
03	13.70	9.85	4.00	11.28
04	14.40	10.55	6.00	11.98
05	17.80	13.95	8.00	15.38
06	18.40	14.55	10.00	15.98
07	21.40	17.55	12.00	18.98
08	22.40	18.55	14.00	19.98
10	26.40	22.55	18.00	23.98
14	36.40	30.55	26.00	31.78

DATE	REV	ECN NO.	DESCRIPTION	MODIFY	APPROVAL	GENERAL TOLERANCE				PART NO.										
						.X	±0.30	.XX	±0.20	2010WRS-XX-PPSNBKR										
						PROJECT				TITLE										
						APPROVAL				2.00 mm Crimp Style Connectors										
						DATE				UNIT SCALE SHEET REV NUMBER										
2023/08/15	C	/	Update Drawing Frame	Starry lin	Larry Yang	.XXX	±0.10	APPROVAL				DATE				UNIT	SCALE	SHEET	REV	NUMBER
2020/03/16	B	EN20200316003	Update Drawing Frame	Alan qin	Robing	X.°	±2°	Jack Zhang	Larry Yang	Starry lin	2018/01/11	mm	1:1	1/2	C	A-000				

SMS 东莞市思索技术股份有限公司
Dongguan SESO Technology Co.,Ltd.

RoHS

This products can apply to the SESO Doc NO. QA-3-04-005 of Environmental&Material Management Rules

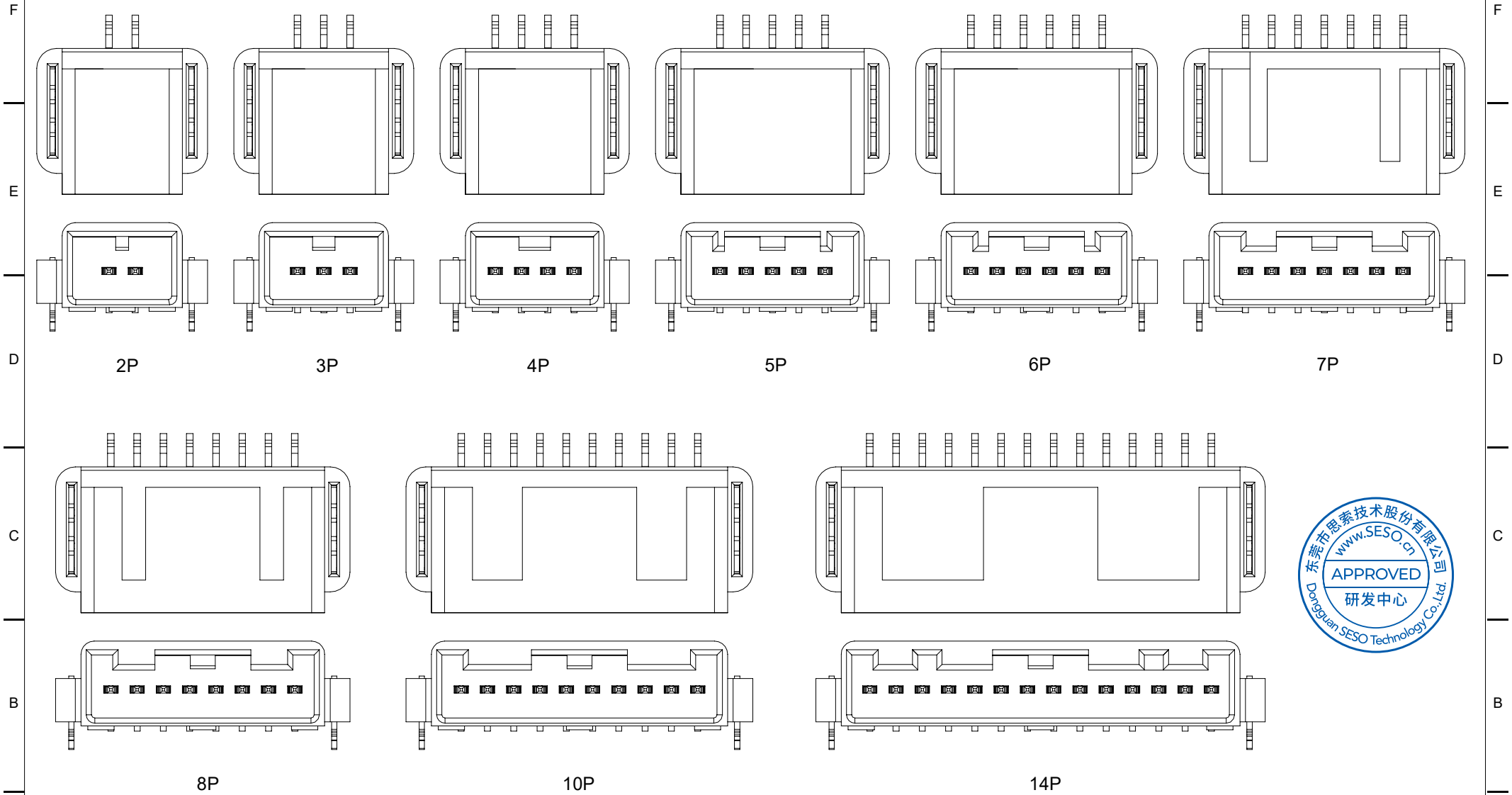

					GENERAL TOLERANCE .X ±0.30 .XX ±0.20 .XXX ±0.10 X.° ±2° PROJECT 				SMS 东莞市思索技术股份有限公司 Dongguan SESO Technology Co.,Ltd.				PART NO. 2010WRS-XX-PPSNBKR																															
					APPROVAL Jack Zhang				CHECK Larry Yang				DRAWN Starry lin				DATE 2018/01/11																											
					Update Drawing Frame Starry lin Larry Yang					Update Drawing Frame Alan qin Robing					TITLE 2.00 mm Crimp Style Connectors																													
2023/08/15 C /					Update Drawing Frame Starry lin Larry Yang					2020/03/16 B EN20200316003					Update Drawing Frame Alan qin Robing					UNIT mm					SCALE 1 : 1					SHEET 2/2					REV C					NUMBER A-000				
DATE 1					REV 2					ECN NO. 3					DESCRIPTION 4					MODIFY 5					APPROVAL 6					7					8									

RoHS

This products can apply to the SESO Doc NO. QA-3-04-005 of Environmental&Material Management Rules

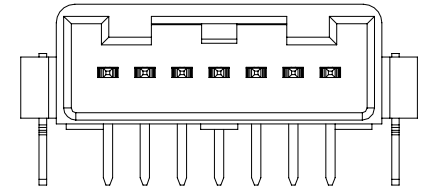
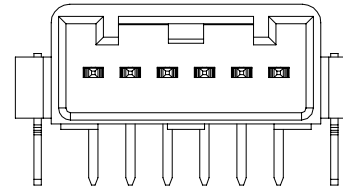
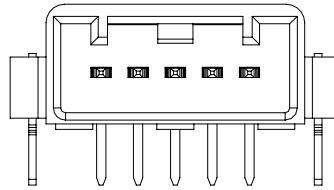
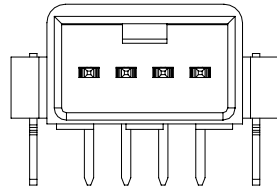
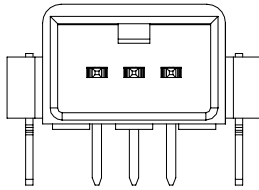
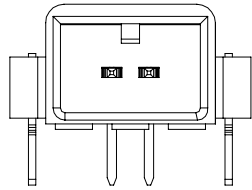
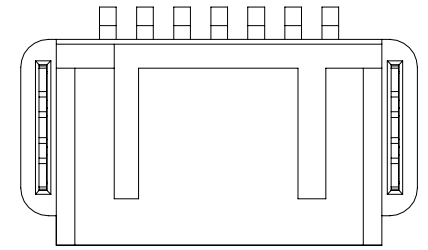
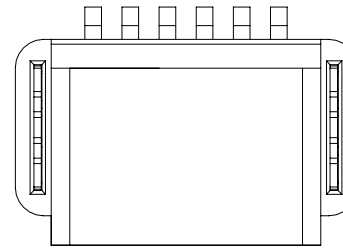
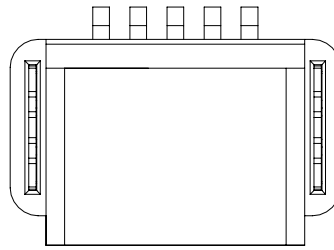
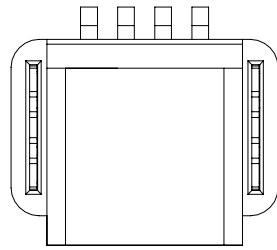
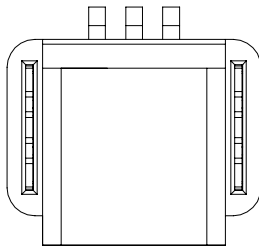
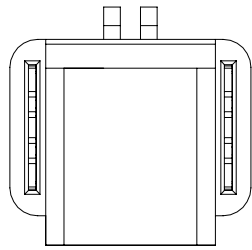

2P

3P

4P

5P

6P

7P

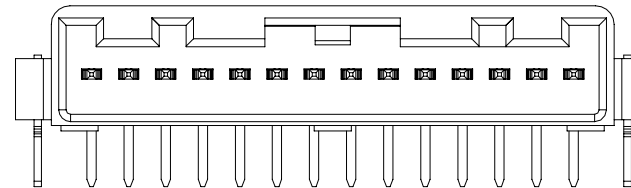
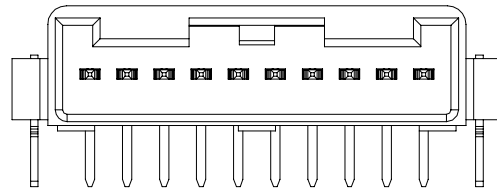
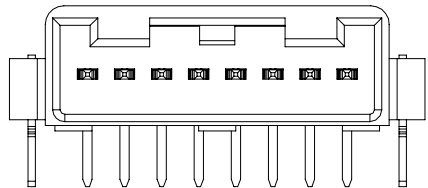
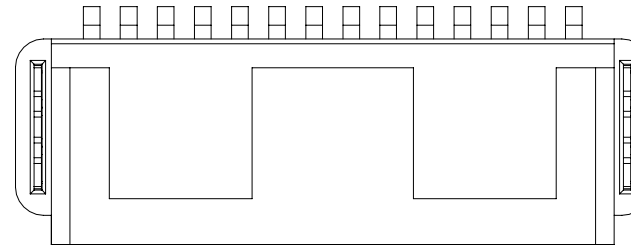
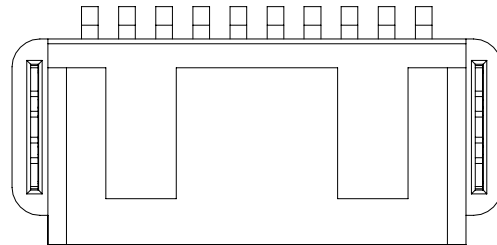
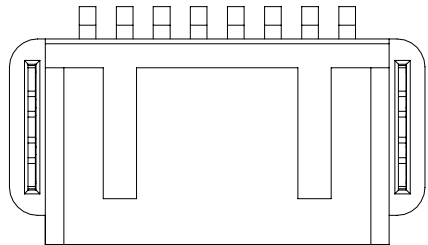

8P

10P

14P



					GENERAL TOLERANCE .X ±0.30 .XX ±0.20 .XXX ±0.10 X.° ±2° PROJECT 				SMS 东莞市思索技术股份有限公司 Dongguan SESO Technology Co.,Ltd.				PART NO. 2010WR-XX-PPSNBKR							
					APPROVAL Jack Zhang				CHECK Larry Yang				DRAWN Starry lin				DATE 2017/05/20			
					TITLE 2.00 mm Crimp Style Connectors															
DATE		REV	ECN NO.		DESCRIPTION				MODIFY		APPROVAL		UNIT	SCALE	SHEET	REV	NUMBER			
1		2	3		4				5		6		7		8		A-000			